

PERFORATED FACE DIFFUSERS

P SERIES

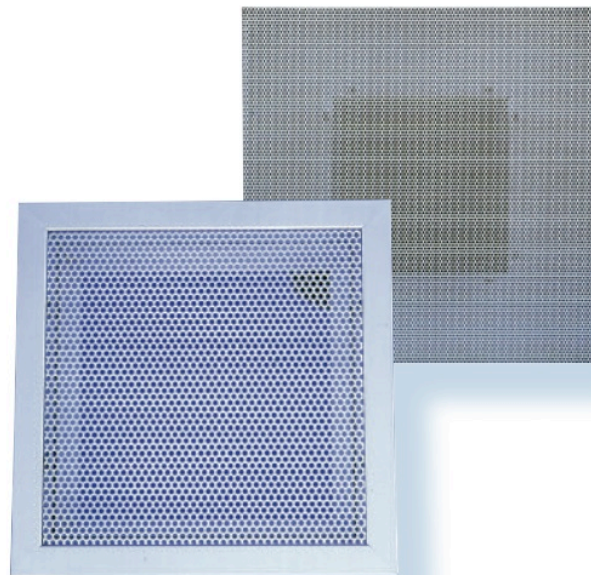

Quality and efficiency without compromise

AIR IN MOTION

PERFORATED FACE DIFFUSERS

P SERIES

QUALITY AND EFFICIENCY WITHOUT
COMPROMISE

Application:

Colman's P Series range of perforated face diffusers have been designed to provide an attractive and flexible solution to a wide variety of air distribution requirements. A centrally mounted deflection plate, on supply diffusers, ensures the square ceiling diffusers provide horizontal air patterns in one, two, three or four way configurations without altering the diffuser's outward appearance. When supplied without deflection plates they are suitable for return air applications. The horizontal air pattern provides complete air discharge around the diffuser periphery including the corners, and the entrainment pattern minimises ceiling smudging.

Description:

The diffusers are offered in four styles, the PT which has no outer frame and is suitable for lay in T bar ceilings, the PS for surface mounting, the PR for recessed mounting and the PX for threadline ceilings. All frames are manufactured from high quality aluminium extrusions with perforated steel face plates. Air discharge pattern blades can be altered on site to modify the diffuser configuration without removal of the unit from its mounting on all models except for PT units. Diffusers are available with square or circular spigots with opposed blade dampers for the former and key operated flap dampers for the latter. All dampers and spigot conversions are made from galvanised steel and dampers are adjustable from the face of the diffuser. Return air diffusers are supplied as standard without a backplate or damper but these can be fitted if required.

Finish:

The diffusers are available as standard, powder coated in RAL 9010 Matt White. Please refer to the product coding section within this brochure for a list of other standard finishes. Special finishes are available on request.

Fixings:

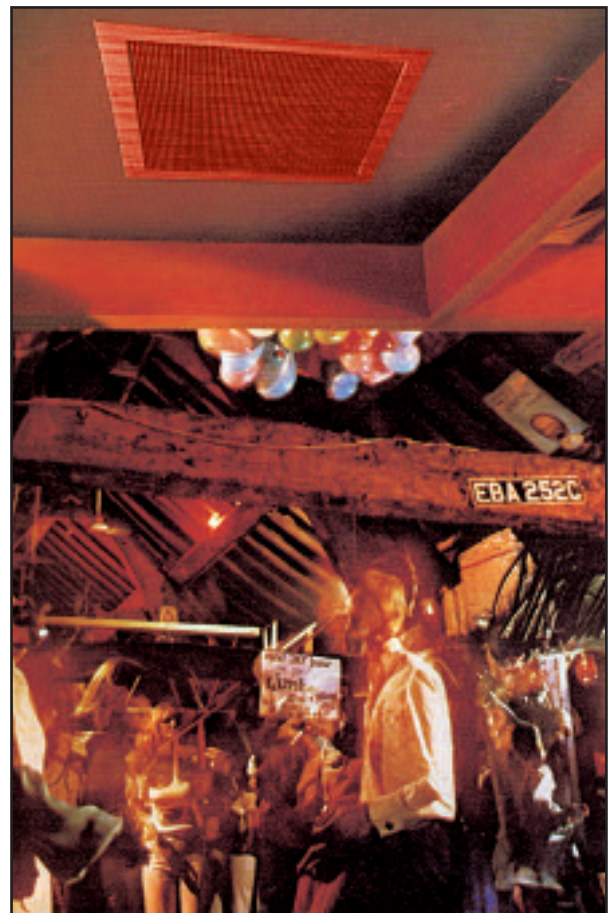
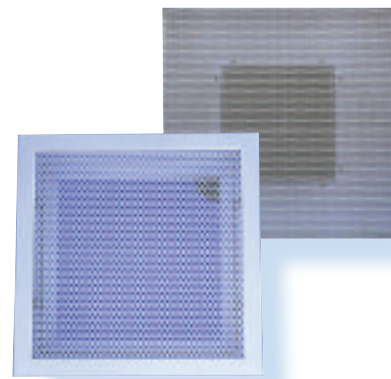

Fixings:

The PT option allows the diffuser to be laid directly within a 600 x 600 mm T bar ceiling grid, whereas PS and PR type diffusers can be fixed directly to the duckwork / plenum via screws or rivets (method 1). All types are provided with side mounted suspension brackets (method 2) for use with drop rods / wires, as standard. Special fixing systems are available on request.

PN Plenum Boxes

Colman manufacture a range of high quality, galvanised sheet steel plenum boxes to suit the square neck sizes of the P series diffusers. Designed to equalise the air distribution across the face of the diffuser, these plenums are available in a standard configuration or purpose made to suit different ceiling, bulkheads or air volumes and are manufactured in acoustically lined or unlined versions. Standard plenum sizes are detailed within this brochure and plenums are supplied with a single circular entry spigot per plenum

as standard, oval or rectangular versions are also available. Diffuser fixing to the plenum is via screws or rivets.

Method 1

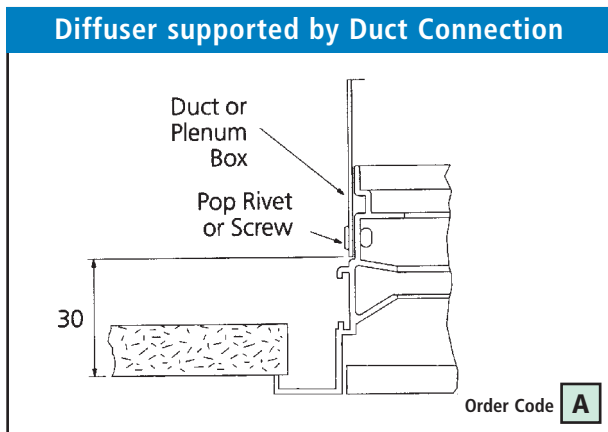

Method 2

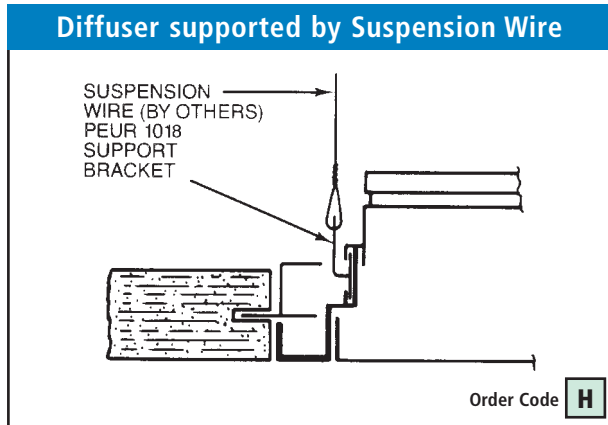

Optional Air Patterns

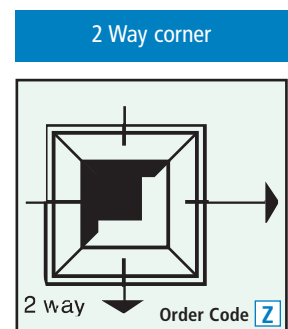
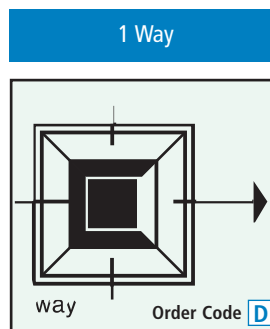
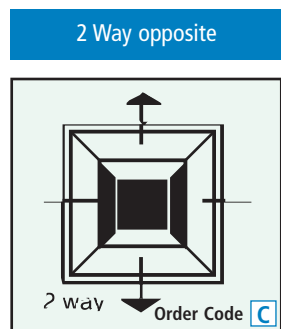
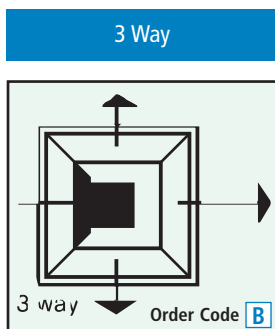

For 4 way (not illustrated) order Code **A**

Plenum box drawing

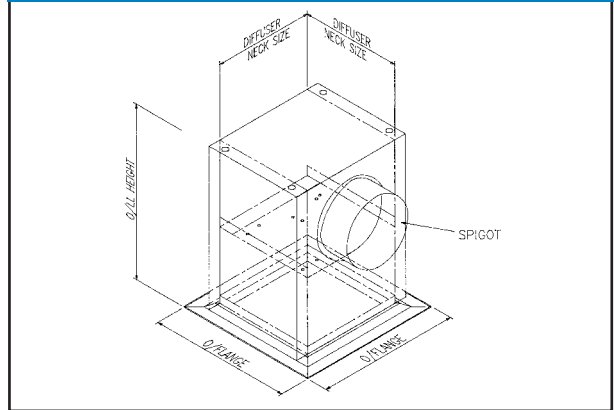

Diffuser Sizes

P Series diffusers are sold in the standard sizes listed below with size codes given by nominal neck and face dimensions. The table below gives the code for each size and the actual dimensions are shown later in this brochure. (Other sizes available on request.)

Supply Size Code	Neck Dimension	Nominal Face Dimension
1530	150	300
1560	150	600
2040	200	400
2060	200	600
2550	250	500
2560	250	600
3060	300	600

Extract Size Code	Neck Dimension	Nominal Face Dimension
2530	250	300
3540	350	400
4550	450	500
5560	550	600

Codes are applicable for round or square neck units.

Options and Order Codes

Return Air Grilles

1	2 FRAME	3 NECK	4 ACCESSORIES	5 ARRANGEMENT	6 FIXING	7 FINISH
P	R Recessed Mounting S Surface Mounting T Tee-Bar Mounting X Threadline Mounting (12mm drop face) 1 Special Note: ø PX- For different Threadline ceilings code as Special	R Round Neck S Square Neck 1 Special	0 None F Key operated Flap Damper (round neck) V Key Operated Opposed Blade Damper (square neck) 1 Special X Key operated opposed blade damper, matt black	A 4 way pattern B 3 way pattern C 2 way opposite D 1 way pattern R Full set of 4 pattern blades X Extract Z 2 Way corner pattern 1 Special	A Neck Fixing Pop Rivet or Screw blue print H Hanger Brackets for wires or straps- (PEUR 1018) red print 1 Special RAL9006 Aluminium 3	F RAL9010 Matt White Other standard colours available ; Mill Finish O BS00E55 Gloss White C BS00E55 Satin White H BS00E55 Matt White D RAL9010 Gloss White E RAL9010 Satin White G Special Colours available on request 1

Note: The items shown in red print above and below and in the order code example are the standard options for this product. Unless shown otherwise on any quotation or order the units will be supplied in this configuration.

Example of Order Codes

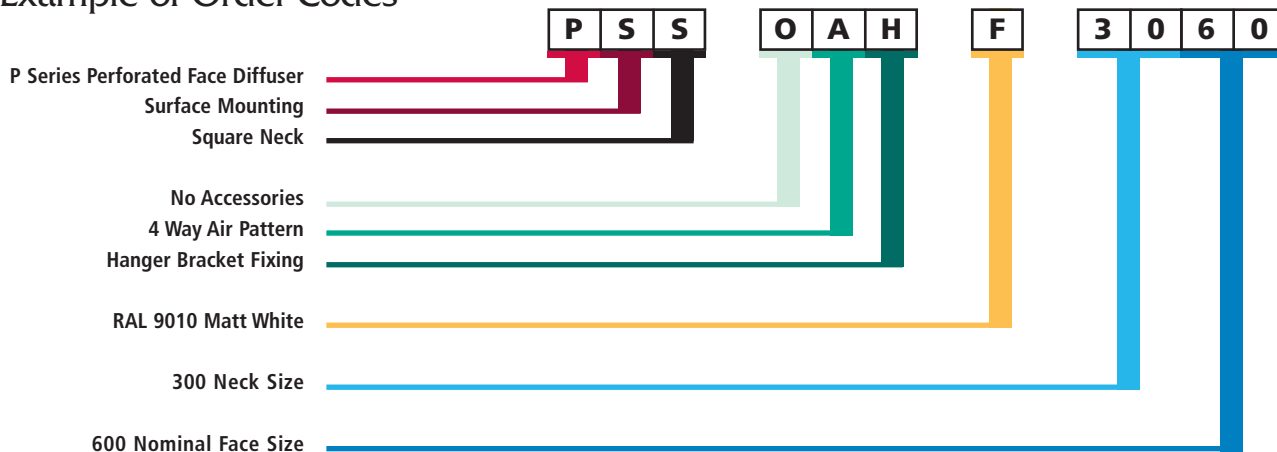

Plenum Boxes

1	2 LINING	3 INSTALLATION METHOD	4 ACCESSORIES	5 ARRANGEMENT	6 SPIGOT TYPE	7 SPIGOT SIZE (DIA or SQ - all in mm)
P	L Lined N Unlined 1 Special	0 Straight Edge 1 Special	0 None 1 Special P.No accessories printed matt black (internally only)	S Supply E Extract 1 Special	R Round - side entry S Square - side entry T Round - top entry W Round - flush with top of unit X Square - flush with top of unit Y Square - Top Entry 1 Special	A 100 B 125 C 150 L 160 T 175 M 180 D 200 R 225 E 250 P 280 F 300 N 315 G 350 S 355 H 400 J 450 K 500 1 Special All Standard Spigots are 75mm deep.

Specifications:

The P Series Perforated diffuser is manufactured from 1.5mm extruded aluminium to BS1474/6063T6. Outer frames are mitred and fully welded. Perforated faceplates are removable on PS, PR and PX diffusers. Adjustable baffle plates are available for different air patterns. These can be fixed on site.

Selection Information

The following pages give details on how to correctly select the P Series Diffusers, together with a worked example. Please read the notes carefully and contact us should you have any queries.

Table 1: Spigot velocity against NR rating

Sound Rating NR	Spigot Velocity m/s
25	2.5
30	3
35	3.5
40	4.5

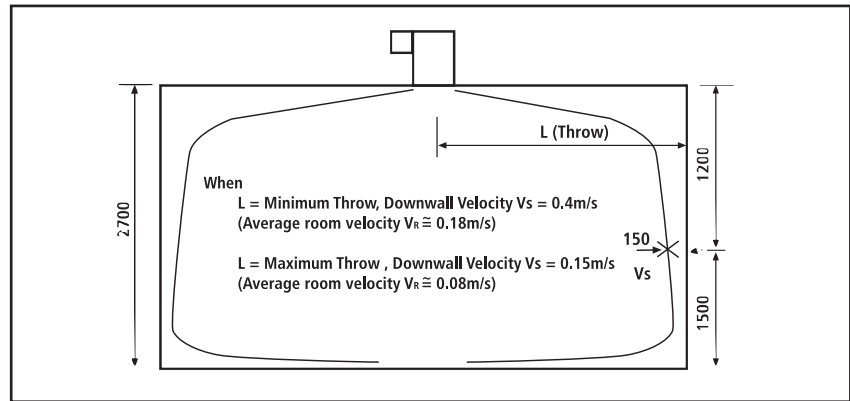

Table 2: Correction figures for dampers

Diffuser Air Pattern	Diffuser Size							
	15.30		20.40		25.50		30.60	
	pd	NR	pd	NR	pd	NR	pd	NR
4-way	1.3	+4	1.0	+3	1.0	+2	1.0	+1
3-way	1.2	+3	1.0	+2	1.0	+2	1.0	+1
2-way	1.1	0	1.0	+1	1.0	0	1.0	+1
1-way	1.0	+2	1.0	0	1.0	0	1.0	0

Throw

If two diffusers are to throw towards each other, select an air volume that gives a maximum throw equal to half the distance between the two.

Minimum throw can be used when discharging towards a wall or window.

Where there is no ceiling effect, throw is reduced by approximately 40%, and air will be discharged downward at an angle of approx 20° from the horizontal.

Plenums

Select the appropriate spigot velocity to match the NR rating required, as per table 1.

Pressure Drop

The pressure drop is given for the diffuser only. When used with a plenum box the following corrections are applied:

Supply Unit Ps x 2.2, NR + 5

Connections and Dampers

Figures given are based on correctly aligned connections and good air approach conditions to the diffuser and without dampers. If connections are misaligned, noise and pressure drop figures will increase greatly. If dampers are fitted use the correction figures in table 2.

Typical Selection

Given: Zone Size of 5m x 5m x 2.7m high
Required NR level of 30
10 Air changes per Hour

1) Calculate Air Volume required:

Room Volume = Length - 5m x Width - 5m x Height - 2.7m = 67.5m³
Multiplied by the required number of air changes - 10 = 675m³/hr
Divided by the number of seconds per hour - 3600 = 0.188m³/s

2) Decide position of Diffuser:

Assuming the diffuser is positioned centrally in the zone, a 4 way throw of 2.5m would be required to fully distribute the air in the room.

3) Select Diffuser:

From the performance data given on page 6, a 3060 diffuser with a volume of 175l/s would give a throw of between 1.4m and 3.6m, at NR 20, as selections should be based on mid range, this diffuser would be suitable in this instance.

4) Select Spigot Size:

Spigot Area = Total volume ÷ Maximum allowed velocity
0.188m³/s ÷ 3m/s = 0.063 m²

Area of 300mm Dia spigot = πr² = 3.142 x 0.15² = 0.071 m²
Therefore the plenum would be fitted with a centrally positioned 300mm Dia spigot.

Note: Although the basic selection is now made the points shown below should be checked.

Check No.1 - Ceiling Height

For ceiling heights greater than 2.7m, the throw is reduced by 5% for each additional 0.3m up to a maximum ceiling height of 4.2m.

Check No. 2 - NR Level

To ensure that the air velocity in the spigot does not cause excessive noise the figures given in Table 1 should be noted.

i.e. Total volume ÷ area of spigot = Velocity
So - 0.188 ÷ 0.071 = 2.65m/s

From Table 1 this gives <NR 30, which is within the specified limit.

Check No. 3 - Plenum Height

If site conditions dictate a height limitation, the following calculation can be used to check the minimum recommended height for the plenums. If these are found to be too high please contact the sales office for advice on alternative plenum arrangements.

Calculation = Spigot dia + 125mm for diffusers with or without dampers

Models PS/PR/PT/PX Supply

Air Volume l/sec	Diffuser Size	4 WAY PATTERN				3 WAY PATTERN				2 WAY PATTERN				1 WAY PATTERN				
		Throw-m.		Ps	NR	Throw-m.		Ps	NR	Throw-m.		Ps	NR	Throw-m.		Ps	NR	
		min.	max	Pa	NR	min.	max	Pa	NR	min.	max	Pa	NR	min.	max	Pa	NR	
25	15.30	0.6	3.0	1	-	0.7	3.1	2	-	0.9	3.3	4	15	1.6	4.0	17	34	*
	15.60	0.6	3.0	1	-	0.7	3.1	2	-	0.9	3.3	4	15	1.6	4.0	17	34	
	20.40	0.3	2.7	-	-	0.4	2.8	1	-	0.6	3.0	2	-	1.3	3.7	9	20	*
	20.60	0.3	2.7	-	-	0.4	2.8	1	-	0.6	3.0	2	-	1.3	3.7	9	20	
50	15.30	0.9	3.3	4	15	1.1	3.5	7	20	1.6	4.0	17	34	-	-	-	-	*
	15.60	0.9	3.3	4	15	1.1	3.5	7	20	1.6	4.0	17	34	-	-	-	-	
	20.40	0.6	3.0	2	-	0.8	3.2	4	-	1.3	3.7	9	20	-	-	-	-	*
	20.60	0.6	3.0	2	-	0.8	3.2	4	-	1.3	3.7	9	20	-	-	-	-	
	25.50	0.4	2.5	-	-	0.5	2.7	1	-	0.9	3.2	2	-	1.9	4.6	10	30	
	25.60	0.4	2.5	-	-	0.5	2.7	1	-	0.9	3.2	2	-	1.9	4.6	10	30	
	30.60	-	-	-	-	0.4	2.0	-	-	0.8	2.6	2	-	1.7	3.9	7	22	
75	15.30	1.3	3.7	10	24	1.6	4.0	17	34	-	-	-	-	-	-	-	-	*
	15.60	1.3	3.7	10	24	1.6	4.0	17	34	-	-	-	-	-	-	-	-	
	20.40	1.0	3.4	5	-	1.3	3.7	9	20	1.9	4.3	19	36	-	-	-	-	*
	20.60	1.0	3.4	5	-	1.3	3.7	9	20	1.9	4.3	19	36	-	-	-	-	
	25.50	0.6	2.8	1	-	0.9	3.2	2	-	1.4	3.9	5	23	2.8	6.0	20	47	
	25.60	0.6	2.8	1	-	0.9	3.2	2	-	1.4	3.9	5	23	2.8	6.0	20	47	
	30.60	0.5	2.2	-	-	0.8	2.6	2	-	1.2	3.2	4	17	2.6	5.3	15	35	
100	15.30	1.6	4.0	17	34	-	-	-	-	-	-	-	-	-	-	-	-	*
	15.60	1.6	4.0	17	34	-	-	-	-	-	-	-	-	-	-	-	-	
	20.40	1.3	3.7	9	20	1.7	4.1	15	30	-	-	-	-	-	-	-	-	*
	20.60	1.3	3.7	9	20	1.7	4.1	15	30	-	-	-	-	-	-	-	-	
	25.50	0.9	3.2	2	-	1.2	3.6	4	21	1.9	4.6	10	30	-	-	-	-	
	25.60	0.9	3.2	2	-	1.2	3.6	4	21	1.9	4.6	10	30	-	-	-	-	
	30.60	0.8	2.6	1	-	1.0	3.0	2	15	1.7	3.9	7	22	-	-	-	-	
125	15.30	1.9	4.3	26	47	-	-	-	-	-	-	-	-	-	-	-	-	*
	15.60	1.9	4.3	26	47	-	-	-	-	-	-	-	-	-	-	-	-	
	20.40	1.6	4.0	13	28	2.1	4.5	24	42	-	-	-	-	-	-	-	-	*
	20.60	1.6	4.0	13	28	2.1	4.5	24	42	-	-	-	-	-	-	-	-	
	25.50	1.1	3.5	4	16	1.5	4.1	6	24	2.3	5.3	14	39	-	-	-	-	
	25.60	1.1	3.5	4	16	1.5	4.1	6	24	2.3	5.3	14	39	-	-	-	-	
	30.60	1.0	2.9	3	-	1.4	3.5	5	18	1.7	3.9	11	28	-	-	-	-	
150	20.40	1.9	4.3	19	36	-	-	-	-	-	-	-	-	-	-	-	-	*
	20.60	1.9	4.3	19	36	-	-	-	-	-	-	-	-	-	-	-	-	
	25.50	1.4	3.9	5	23	1.9	4.6	10	30	-	-	-	-	-	-	-	-	
	25.60	1.4	3.9	5	23	1.9	4.6	10	30	-	-	-	-	-	-	-	-	
	30.60	1.2	3.2	4	17	1.7	3.9	7	22	2.6	5.3	15	35	-	-	-	-	
175	20.40	2.2	4.6	26	44	-	-	-	-	-	-	-	-	-	-	-	-	*
	20.60	2.2	4.6	26	44	-	-	-	-	-	-	-	-	-	-	-	-	
	25.50	1.6	4.2	7	25	2.2	5.0	12	36	-	-	-	-	-	-	-	-	
	25.60	1.6	4.2	7	25	2.2	5.0	12	36	-	-	-	-	-	-	-	-	
	30.60	1.4	3.6	5	20	1.9	4.4	9	25	3.0	6.0	20	43	-	-	-	-	
200	25.50	1.9	4.6	10	30	2.5	5.5	16	42	-	-	-	-	-	-	-	-	
	25.60	1.9	4.6	10	30	2.5	5.5	16	42	-	-	-	-	-	-	-	-	
	30.60	1.7	3.9	7	22	2.3	4.9	12	30	-	-	-	-	-	-	-	-	
225	25.50	2.1	4.9	11	34	-	-	-	-	-	-	-	-	-	-	-	-	
	25.60	2.1	4.9	11	34	-	-	-	-	-	-	-	-	-	-	-	-	
	30.60	1.9	4.3	9	24	2.6	5.3	15	35	-	-	-	-	-	-	-	-	
250	25.50	2.3	5.3	14	39	-	-	-	-	-	-	-	-	-	-	-	-	
	25.60	2.3	5.3	14	39	-	-	-	-	-	-	-	-	-	-	-	-	
	30.60	2.1	4.6	11	28	2.8	5.7	19	39	-	-	-	-	-	-	-	-	
275	25.50	2.6	5.6	17	43	-	-	-	-	-	-	-	-	-	-	-	-	
	25.60	2.6	5.6	17	43	-	-	-	-	-	-	-	-	-	-	-	-	
	30.60	2.3	5.0	13	32	-	-	-	-	-	-	-	-	-	-	-	-	
300	25.50	2.8	6.0	20	47	-	-	-	-	-	-	-	-	-	-	-	-	
	25.60	2.8	6.0	20	47	-	-	-	-	-	-	-	-	-	-	-	-	
	30.60	2.6	5.3	15	35	-	-	-	-	-	-	-	-	-	-	-	-	
325	30.60	2.8	5.7	18	39	-	-	-	-	-	-	-	-	-	-	-	-	

1) Data is applicable for both square and round neck units.
 2) All NR ratings based on room absorption of 8dB, dampers fully open. Where no figure is given in NR column the rating is <NR20.
 * 3) Items shown in red are only available in PS (surface mount) frame styles.

Models PS/PR/PT/PX Return

Air volume (l/s)	SQUARE NECKS			
	Size	Neck Velocity m/s	▲Ps Pa	NR
100	25.30	1.6	8	-
	35.40	0.8	2	-
150	25.30	2.4	19	-
	35.40	1.2	5	-
200	25.30	3.2	32	-
	35.40	1.6	10	-
	45.50	1.0	4	-
250	25.30	4.0	50	24
	35.40	2.0	14	-
	45.50	1.2	5	-
	50.60	0.8	3	-
300	25.30	4.8	73	29
	35.40	2.4	21	-
	45.50	1.5	8	-
	55.60	1.0	4	-
350	35.40	2.9	29	-
	45.50	1.7	11	-
	55.60	1.2	5	-
400	35.40	3.3	36	22
	45.50	2.0	14	-
	55.60	1.3	6	-
450	35.40	3.7	47	26
	45.50	2.2	17	-
	55.60	1.5	8	-
500	35.40	4.1	59	29
	45.50	2.5	23	-
	55.60	1.7	10	-
550	45.50	2.7	27	20
	55.60	1.8	13	-
600	45.50	3.0	32	22
	55.60	2.0	14	-
650	45.50	3.2	36	24
	55.60	2.1	17	-
700	45.50	3.5	44	27
	55.60	2.3	21	-
750	45.50	3.7	50	29
	55.60	2.5	23	20

Air volume (l/s)	ROUND NECKS			
	Neck Size	Neck Velocity m/s	▲Ps Pa	NR
50	150	2.8	11	-
	200	1.6	4	-
100	150	5.7	45	27
	200	3.2	14	-
	250	2.0	6	-
150	300	1.4	3	-
	200	4.8	32	23
	250	3.1	13	-
200	300	2.1	6	-
	200	6.4	56	30
	250	4.1	23	-
250	300	2.8	11	-
	250	5.1	26	24
	300	3.5	17	-
300	250	6.1	51	29
	300	4.2	24	20
350	300	5.0	34	24
400	300	5.7	45	27
450	300	6.4	56	30

1) Data is applicable for unducted units without dampers.

2) All NR ratings are based on room absorption of 8dB.

Where no figure is given in NR column the rating is <NR20

Models PS/PR/PT/PX faceplate Removal

The perforated diffusers allow for faceplate removal whilst the unit is in position and the diagrams show details of the removal method:

- 1) Locate positions of faceplate retaining clips which are fitted on two opposite sides of diffuser, these can be seen through the faceplate.
- 2) Insert a hook through a hole in the faceplate behind the retaining clip. Depress clip and at the same time pull downwards (Fig. 1).
- 3) Disengage the hook and insert it behind clip on opposite edge of faceplate, proceed as in (Fig.2.)

Holding the free edge of the faceplate pull downwards gently and this will release the faceplate from the remaining clips (Fig. 3). (Hooks are not supplied with diffusers).

Dropped faceplates :

Are available on all PS, PR & PX diffusers, however performance figures will vary with design. Please contact your local sales office for advice.

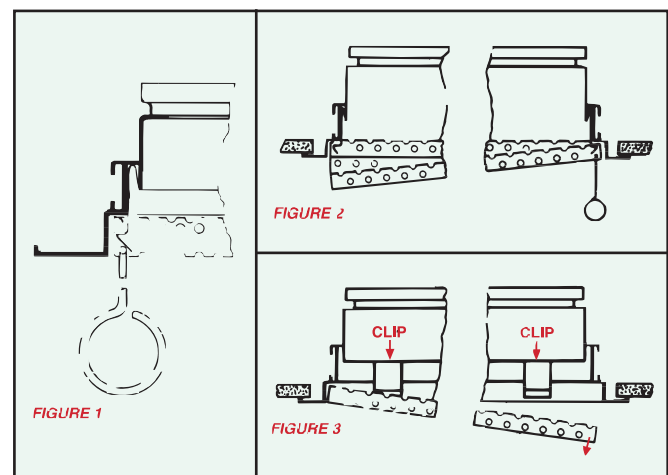

PSS Diffuser Surface

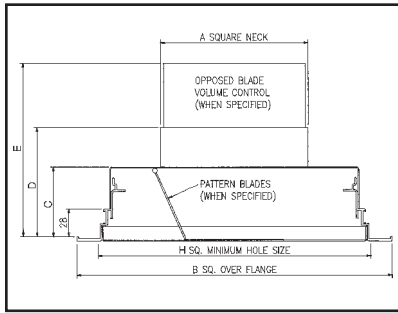

Size	A	B	C	D	E	H
1530	148	320	50	90	150	275
1560	148	620	50	90	150	575
2040	198	420	50	90	150	375
2060	198	620	50	90	150	575
2550	248	520	70	110	170	475
2560	248	520	70	110	170	475
3060	298	620	70	110	170	575

PRS Diffuser Recess

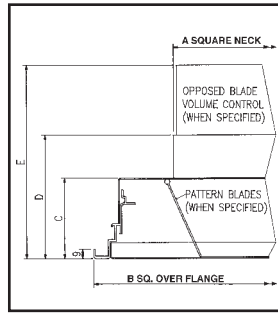

Size	A	B	C	D	E
1550	148	499	55	95	155
2050	198	499	55	95	155
2550	248	499	75	115	175
1560	148	599	55	95	155
2060	198	599	55	95	155
2560	248	599	75	115	175
3060	298	599	75	115	175

PTS Diffuser T-Bar

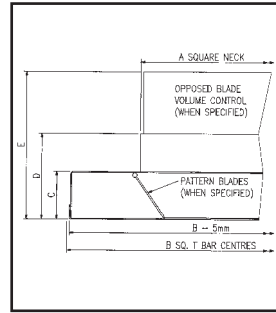

Size	A	B	C	D	E
1550	148	500	50	90	150
2050	198	500	50	90	150
2550	248	500	75	115	175
1560	148	600	50	90	150
2060	198	600	50	90	150
2560	248	600	75	115	175
3060	298	600	75	115	175

PXS Diffuser Threadline

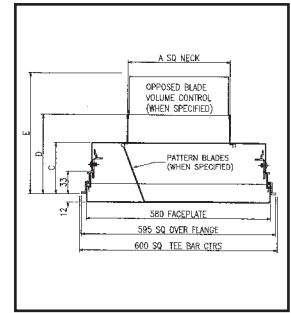

Size	A	C	D	E
1560	148	55	95	155
2060	198	55	95	155
2560	248	75	115	175
3060	298	75	115	175

PSR Diffuser Surface

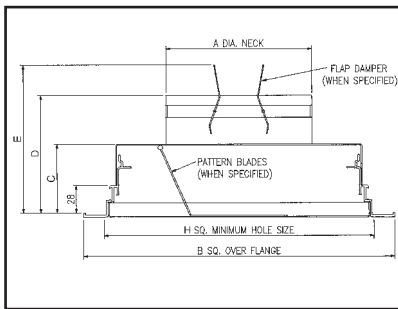

Size	A	B	C	D	E	H
1530	148	320	50	100	125	275
1560	148	620	50	100	125	575
2040	198	420	50	100	150	375
2060	198	620	50	100	150	575
2550	248	520	70	120	195	475
2560	248	620	70	120	195	575
3060	298	620	70	120	220	575

PRR Diffuser Recess

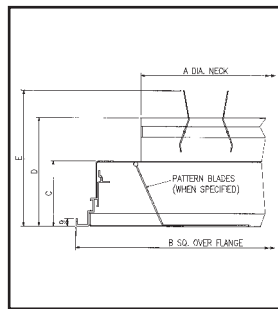

Size	A	B	C	D	E
1550	148	499	55	105	130
2050	198	499	55	105	150
2550	248	499	75	125	205
1560	148	599	55	105	130
2060	198	599	55	105	155
2560	248	599	75	125	205
3060	298	599	75	125	230

PTR Diffuser T-Bar

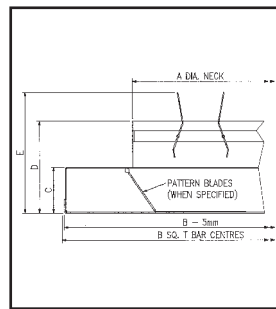

Size	A	B	C	D	E
1550	148	500	50	100	125
2050	198	500	50	100	150
2550	248	500	75	125	200
1560	148	600	50	100	125
2060	198	600	50	100	150
2560	248	600	75	125	200
3060	298	600	75	125	225

PXR Diffuser Threadline

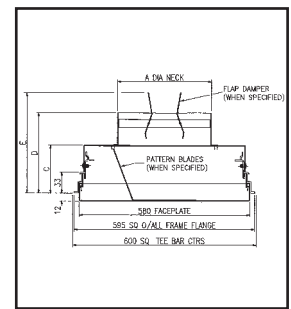

Size	A	C	D	E
1560	148	55	105	130
2060	198	55	105	155
2560	248	75	125	205
3060	298	75	125	230

PSS Extract Surface

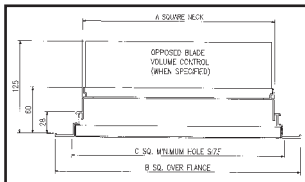

PSS Extract				
Size	A	B	C	
2530	250	320	275	
3540	350	420	375	
4550	450	520	475	
5560	550	620	575	

PRS Extract Recess

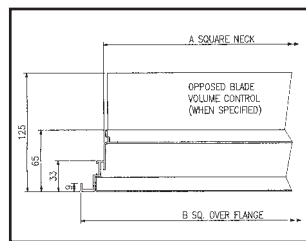

PRS Extract				
Size	A	B		
4550	450	500		
5560	550	600		

PTS Extract T-Bar

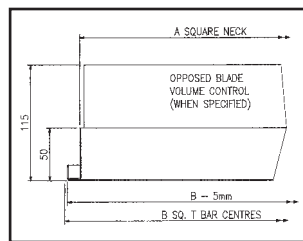

PTS Extract				
Size	A	B		
4550	450	499		
5560	550	599		

Plenum Arrangement

