

RETURN AIR GRILLES

G SERIES

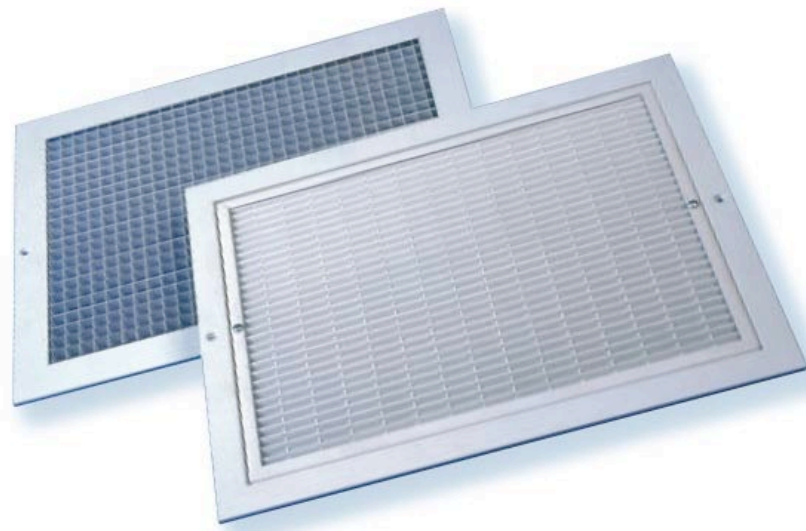

Quality and efficiency without compromise

AIR IN MOTION

RETURN AIR GRILLES

G SERIES

QUALITY AND EFFICIENCY WITHOUT COMPROMISE

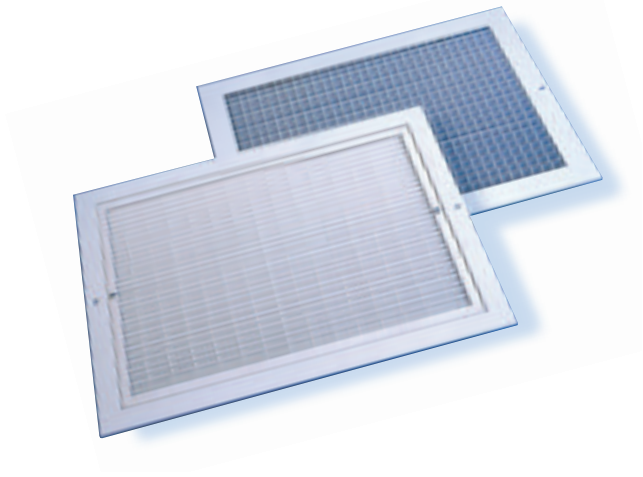

Application:

Colman Moducels range of Return Air Grilles have been designed to complement our Supply Diffusers for both side wall and ceiling applications. The range is available in a wide variety of styles and sizes to suit individual application requirements.

Description:

With three standard frames and four styles of core, the range provides a flexible group of grilles to meet most functional and installation requirements.

Grilles utilising our 'B' style frame have integral cores which are retained by spring clips on the rear of the extrusion, whilst the 'H' style houses the core in a U channel panel frame, removable from the face and allowing access to the duct without having to remove the whole grille.

Fixings:

The most common method for fixing our range of Return

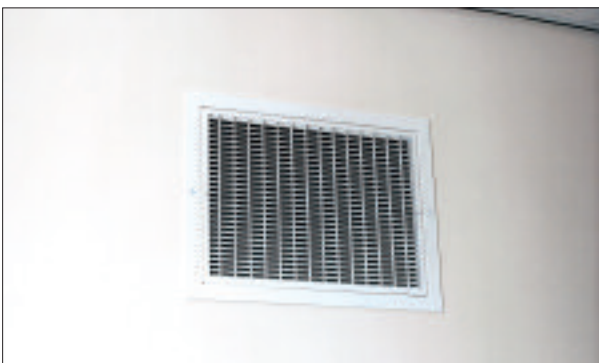

Air Grilles is screw fixing through the flange face (method G) or through the flange neck (method A). However, to suit the wide selection of products within this range a number of alternative standard fixing arrangements are available, see the product coding section of this brochure for additional information.



All models are available with opposed blade volume control dampers operable from the face of the grille and sealing gasket is available as an option.

Finish:

Return Air Grilles are available as standard in powder coated RAL 9010 Matt White.

Grilles which are manufactured totally from aluminium are also available in a natural anodised finish, please contact sales office for availability.

Please refer to the product coding section of this brochure for a list of other standard finishes. Special finishes are available upon request.

All grilles are pre-treated utilising a six stage phosphate conversion process conforming to ISO 9171 prior to being powder coated in accordance with BS6496.

Options and Order Codes

Return Air Grilles

1	2 FRAME	3 CORE	4 ACCESSORIES	5 ARRANGEMENT	6 FIXING	7 FINISH
G	0 Core only B 32mm frame for fixed core H 25mm frame for removable core U Channel Note see product data sheet for frame sizes.	E Steel fixed blade F Aluminium bar set at 45° V Steel non-vision X 12.5mm aluminium lattice Note see product data sheet for frame sizes.	0 None V Face operated volume control damper X Face operated volume control damper (painted matt black)	0 None A 100mm dia top conversion B 125mm dia top conversion C 150mm dia top conversion D 200mm dia top conversion E 250mm dia top conversion F 300mm dia top conversion G 350mm dia top conversion H 400mm dia top conversion J 450mm dia top conversion K 500mm dia top conversion L 100mm sq top conversion M 125mm sq top conversion N 150mm sq top conversion P 200mm sq top conversion Q 250mm sq top conversion R 350mm sq top conversion T 400mm sq top conversion V 450mm sq top conversion W 500mm sq top conversion 1 Special	0 None A Screw fixing thro neck D Universal extended bracket G Screw fixing thro flange H Hanger bkt Ceur 1140 S Steel hanger bkt fitted to conversion U Universal bracket X Extended hanger bracket Note 1/ Code D for diffuser with VCD's only. 2/ Code D, E, H, U, X to be used only with B frame. 3/ Code S or G to be used with B, H, frame when conversion required.	0 Mill finish F Ral 9010 Matt white A Anodised 9 Satin anodised 8 Matt black C BS00E55 Gloss H BS00E55 Satin D BS00E55 Matt E Ral 9010 Gloss G Ral 9010 Satin 3 Ral 9006 Aluminium 1 Special colours Note A and 9 can only be used with aluminium cores.

Note: The items shown in red print above and below in the code example are the standard option for this product. Unless shown otherwise on any quotation or order the units will be supplied in this configuration.

Example of Order Codes

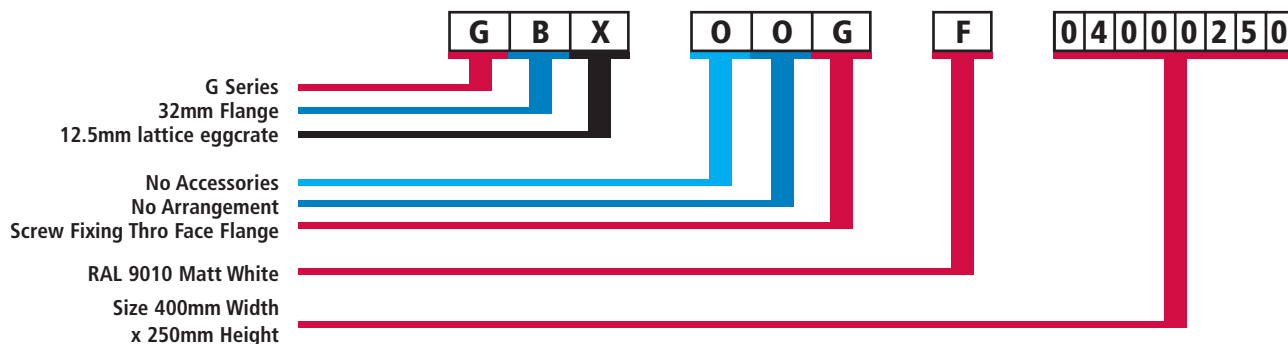

Plenum Boxes

1	2 LINING	3 INSTALLATION	4 ACCESSORIES	5 ARRANGEMENT	6 SPIGOT TYPE	7 SPIGOT SIZE
G	L Lined (6mm Bestobell) N Unlined	0 None U Universal brackets	0 None M Mono blade cord operated damper N Mono blade cord operated damper painted matt black (internally only) P No accessories painted matt black (internally only) Note: Max size mono blade 400 dia 350sq	E Extract	R Round - Side entry S Square - Side entry T Round - Top entry W Round - Flush with top of unit X Square - Flush with top of unit Y Square-Top entry 1 Special	A 100 B 125 C 150 D 200 E 250 F 300 G 350 H 400 J 450 K 500 L 160 M 180 N 224 P 280 R 315 S 355 1 Special

Performance Date

X Core Return								
Air Volume m ³ /s	Face Velocity (m/s)							
	2		2.5		3		4	
	m ²	NR	m ²	NR	m ²	NR	m ²	NR
.05	.025	-	.02	-	.017	16	.013	25
.075	.038	-	.03	-	.025	18	.019	26
.10	.05	-	.04	-	.033	18	.025	28
.125	.063	-	.05	-	.042	19	.031	29
.15	.075	-	.06	-	.05	21	.038	29
.175	.088	-	.07	16	.058	21	.044	30
.20	.10	-	.08	17	.067	22	.05	30
.25	.125	-	.10	17	.083	23	.063	31
.30	.15	-	.12	18	.10	24	.075	32
.35	.175	-	.14	19	.117	24	.088	33
.40	.20	-	.16	20	.133	25	.10	34
.45	.225	-	.18	20	.15	25	.113	34
.50	.25	-	.20	21	.167	26	.125	35
.60	.30	-	.24	21	.20	27	.15	35
.70	.35	-	.28	22	.233	27	.175	36
.80	.40	-	.32	23	.267	28	.20	37
.90	.45	-	.36	23	.30	28	.225	37
1.00	.50	16	.40	24	.333	29	.25	38
1.25	.625	17	.50	25	.417	30	.313	39
1.50	.75	17	.60	25	.50	31	.375	39
1.75	.875	18	.70	26	.583	31	.438	40
2.00	1.00	19	.80	27	.667	32	.50	40

Pressure Drop Data				
Face Velocity (m/s)	Core Style			
	E Core	F Core	X Core	V Core
0.5	1	1	1	2
1	3	3	2	9
1.5	8	7	4	20
2	14	13	7	35
2.5	21	22	12	
3	31	30	17	
3.5	42	42	23	
4	55	53	29	
4.5	69	71	37	
5	85	88	46	

The face velocity through return grilles with 'V' core should not exceed 2m/s.

These data tables should be used in conjunction with the relevant core area chart.

NR Ratings and Core Areas

E Core Return								
Air Volume m ³ /s	Face Velocity (m/s)							
	1.5		2.0		2.5		3.0	
	m ²	NR	m ²	NR	m ²	NR	m ²	NR
.050	.033	-	.025	18	.020	24	.017	28
.075	.050	-	.038	20	.030	26	.025	30
.100	.067	-	.050	21	.040	27	.034	31
.125	.083	-	.063	22	.050	28	.042	32
.150	.100	-	.075	23	.060	29	.050	33
.175	.117	-	.088	24	.070	29	.059	34
.200	.133	-	.100	24	.080	30	.067	35
.225	.155	17	.113	25	.090	31	.078	35
.250	.167	17	.125	25	.100	31	.084	36
.275	.183	18	.138	26	.110	32	.092	36
.300	.200	18	.150	26	.120	32	.100	37
.350	.233	19	.175	26	.140	33	.117	37
.400	.267	19	.200	27	.160	33	.134	38
.450	.300	20	.225	28	.180	34	.150	38
.500	.333	20	.250	28	.200	34	.167	38
.550	.367	21	.275	29	.220	35	.184	39
.600	.400	21	.300	29	.240	35	.200	40
.650	.433	22	.325	29	.260	35	.217	40

F Core Return								
Air Volume m ³ /s	Face Velocity (m/s)							
	1.5		2		2.5		3	
	m ²	NR	m ²	NR	m ²	NR	m ²	NR
.075	.050	-	.038	23	.030	28	.025	31
.100	.067	-	.050	23	.040	28	.033	32
.125	.083	-	.063	24	.050	29	.042	33
.150	.100	-	.075	24	.060	29	.050	33
.175	.117	-	.088	25	.070	30	.058	34
.200	.133	-	.100	25	.080	30	.067	34
.250	.167	-	.125	26	.100	31	.083	35
.300	.200	19	.150	26	.120	31	.100	35
.350	.233	19	.175	27	.140	32	.117	36
.400	.267	20	.200	27	.160	32	.133	36
.450	.300	21	.225	27	.180	33	.150	37
.500	.333	21	.250	28	.200	33	.167	38
.550	.367	22	.275	28	.220	33	.183	38
.600	.400	22	.300	29	.240	34	.200	39
.650	.433	23	.325	29	.260	34	.217	39

Return Air Grille - Core Area Chart

Height	B & H Frame Core Areas																	
	150	200	300	400	500	600	700	800	900	1000	1100	1200	1400	1600	1800	2000	2200	2400
75	0.01	0.01	0.01	0.02	0.02	0.03	0.03	0.04	0.04	0.05	0.05	0.06	0.07	0.08	0.09	0.10	0.11	0.12
100	0.01	0.01	0.02	0.03	0.04	0.04	0.05	0.06	0.07	0.07	0.08	0.09	0.10	0.12	0.13	0.15	0.17	0.18
150	0.02	0.02	0.03	0.05	0.06	0.07	0.09	0.10	0.11	0.12	0.14	0.15	0.17	0.20	0.22	0.25	0.27	0.30
200		0.03	0.05	0.07	0.08	0.10	0.12	0.14	0.15	0.17	0.19	0.21	0.24	0.28	0.31	0.35	0.38	0.42
250			0.06	0.08	0.11	0.13	0.15	0.18	0.20	0.22	0.24	0.27	0.31	0.36	0.40	0.45	0.49	0.54
300			0.08	0.10	0.13	0.16	0.19	0.21	0.24	0.27	0.30	0.32	0.38	0.43	0.49	0.55	0.60	0.66
350				0.12	0.16	0.19	0.22	0.25	0.29	0.32	0.35	0.38	0.45	0.51	0.58	0.64	0.71	0.77
400				0.14	0.18	0.22	0.25	0.29	0.33	0.37	0.40	0.44	0.52	0.59	0.67	0.74	0.82	0.89
450					0.20	0.25	0.29	0.33	0.37	0.42	0.46	0.50	0.59	0.67	0.76	0.84	0.93	1.01
500					0.23	0.27	0.32	0.37	0.42	0.46	0.51	0.56	0.65	0.75	0.85	0.94	1.04	1.13
550						0.30	0.36	0.41	0.46	0.51	0.57	0.62	0.72	0.83	0.93	1.04	1.14	1.25
600						0.33	0.39	0.45	0.50	0.56	0.62	0.68	0.79	0.91	1.02	1.14	1.25	1.37
700							0.46	0.52	0.59	0.66	0.73	0.79	0.93	1.07	1.20	1.34	1.47	1.61
800								0.60	0.68	0.76	0.83	0.91	1.07	1.22	1.38	1.53	1.69	1.84
900									0.77	0.85	0.94	1.03	1.21	1.38	1.56	1.73	1.91	2.08
1000										0.95	1.05	1.15	1.34	1.54	1.73	1.93	2.12	2.32
1100											1.16	1.27	1.48	1.70	1.91	2.13	2.34	2.56
1200												1.38	1.62	1.85	2.09	2.32	2.56	2.79

Height	U Frame Core Areas										Width					
	150	200	250	300	350	400	450	500	550	600	700	800	900	1000	1100	1200
75	0.01	0.01	0.01	0.01	0.02	0.02	0.02	0.03	0.03	0.03	0.04	0.04	0.05	0.05	0.06	0.06
100	0.01	0.01	0.02	0.02	0.03	0.03	0.03	0.04	0.04	0.05	0.05	0.06	0.07	0.08	0.08	0.09
150	0.02	0.02	0.03	0.04	0.04	0.05	0.05	0.06	0.07	0.07	0.09	0.10	0.11	0.13	0.14	0.15
200		0.03	0.04	0.05	0.06	0.07	0.08	0.09	0.09	0.10	0.12	0.14	0.16	0.17	0.19	0.21
250			0.05	0.06	0.07	0.09	0.10	0.11	0.12	0.13	0.15	0.18	0.20	0.22	0.25	0.27
300				0.08	0.09	0.11	0.12	0.13	0.15	0.16	0.19	0.22	0.24	0.27	0.30	0.33
350					0.11	0.12	0.14	0.16	0.17	0.19	0.22	0.26	0.29	0.32	0.35	0.39
400						0.14	0.16	0.18	0.20	0.22	0.26	0.29	0.33	0.37	0.41	0.45
450							0.18	0.20	0.23	0.25	0.29	0.33	0.38	0.42	0.46	0.50
500								0.23	0.25	0.28	0.32	0.37	0.42	0.47	0.52	0.56
550									0.28	0.31	0.36	0.41	0.46	0.52	0.57	0.62
600										0.33	0.39	0.45	0.51	0.57	0.62	0.68
700											0.46	0.53	0.60	0.66	0.73	0.80
800												0.61	0.68	0.76	0.84	0.92
900													0.77	0.86	0.95	1.03
1000														0.96	1.05	1.15
1100															1.16	1.27
1200																1.39

Core only

Core area (m²) = nominal grille height (m) x nominal grille width (m)

Dimensional Data

Return Air Grilles GOX, GUX, GBX, GHX, GBF

GOX



A high free area aluminium lattice core assembly with 12.5 mm square openings.

FREE AREA 90%.

MINIMUM SIZE 150 X 75
MAXIMUM SIZE 1200 X 1200

GUX

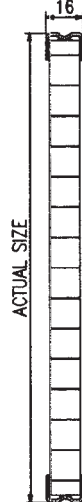

The GOX core assembly fixed into a steel U channel frame.

FREE AREA 90%.

MINIMUM SIZE 150 X 75
MAXIMUM SIZE 1200 X 1200

GBX

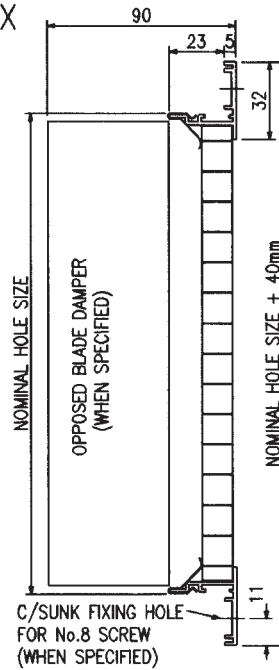

The GOX core assembly held captive within an extruded aluminium outer frame.

FREE AREA 90%.

MINIMUM SIZE 150 X 75
MAXIMUM SIZE 2400 X 1200
MAXIMUM INDIVIDUAL CORE SIZE 1200 X 1200

GHX

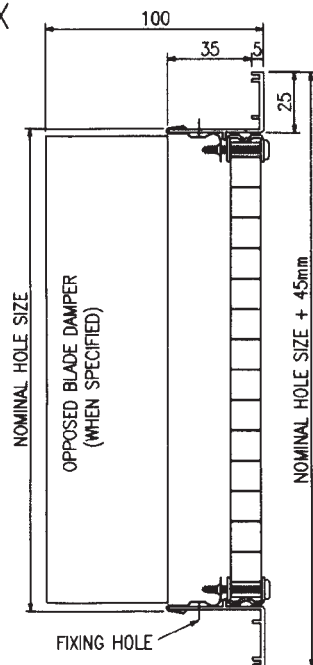

The GUX core assembly fitted into an extruded aluminium outer frame such that it can easily be removed.

FREE AREA 90%.

MINIMUM SIZE 150 X 75
MAXIMUM SIZE 2400 X 1200
MAXIMUM INDIVIDUAL CORE SIZE 1200 X 1200

GBF

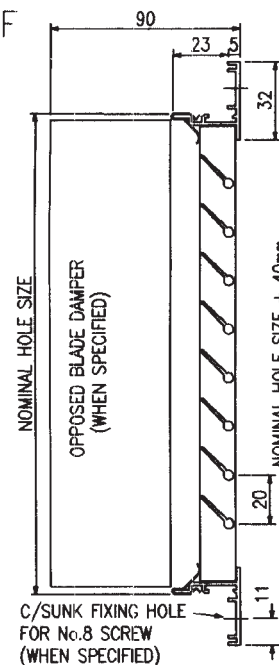

An aluminium core assembly with horizontal blades set 45° and held captive within an extruded aluminium outer frame.

FREE AREA 60%.

MINIMUM SIZE 150 X 75
MAXIMUM SIZE 1800 X 1200
MAXIMUM INDIVIDUAL CORE SIZE 400 X 600

Dimensional Data

Return Air Grilles GOE, GUE, GBE, GHE, GOV, GUV, GBV, GHV

GOE



A steel core assembly with blades fixed at 30°.

MINIMUM SIZE 150 X 75
MAXIMUM SIZE 1200 X 600

FREE AREA 68%.

GUE



The GOE core assembly fixed into a steel U channel frame.

MINIMUM SIZE 150 X 75
MAXIMUM SIZE 1200 X 600

FREE AREA 68%.

GBE

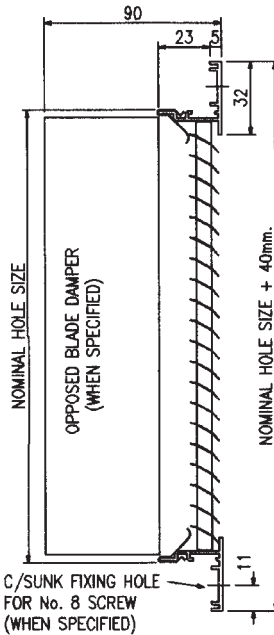

The GOE core assembly held captive within an extruded aluminium frame.

MINIMUM SIZE 150 X 75
MAXIMUM SIZE 2400 X 1200
MAXIMUM INDIVIDUAL CORE SIZE 1200 X 600

FREE AREA 68%.

GHE

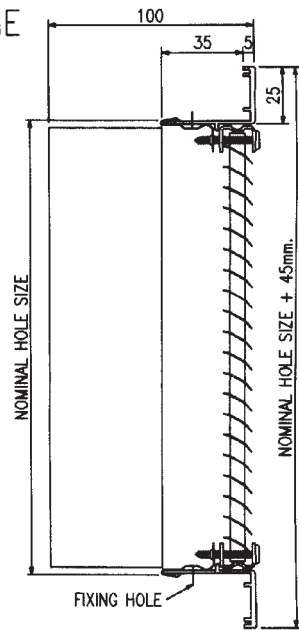

The GUE core assembly fitted into an extruded aluminium outer frame such that it can easily be removed.

MINIMUM SIZE 150 X 75
MAXIMUM SIZE 2400 X 1200
MAXIMUM INDIVIDUAL CORE SIZE 1200 X 600

FREE AREA 68%.

GOV



A steel core assembly with non-vision V shaped blades.

MINIMUM SIZE 150 X 75
MAXIMUM SIZE 1200 X 900

FREE AREA 66%.

GUV



The GOV core assembly fixed into a steel U channel frame.

MINIMUM SIZE 150 X 75
MAXIMUM SIZE 1200 X 900

FREE AREA 66%.

GBV

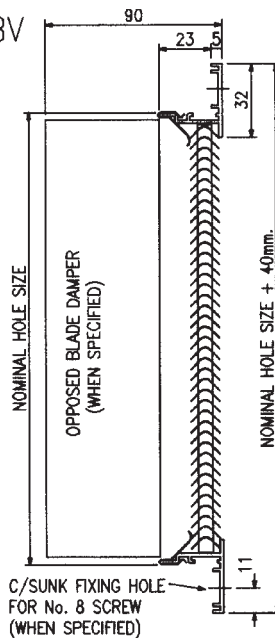

The GOV core assembly held captive within an extruded aluminium frame.

MINIMUM SIZE 150 X 75
MAXIMUM SIZE 2400 X 1200
MAXIMUM INDIVIDUAL CORE SIZE 1200 X 900

FREE AREA 66%.

GHV

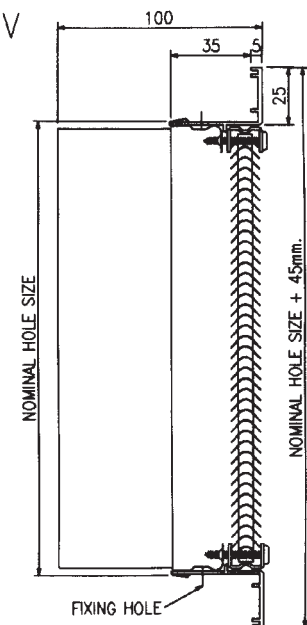

The GUV core assembly fitted into an extruded aluminium outer frame such that it can easily be removed.

MINIMUM SIZE 150 X 75
MAXIMUM SIZE 2400 X 1200
MAXIMUM INDIVIDUAL CORE SIZE 1200 X 900

FREE AREA 66%.

PRODUCT RANGE

AIR HANDLING UNITS

PACKAGED AIR CONDITIONING UNITS

SPLIT SYSTEM AIR CONDITIONING UNITS

TERMINAL PRODUCTS

Fan Coil

VAV

Constant Volume

Induction

Fan Assisted VAV

HEAT RECOVERY PLANT

HEAT PUMPS

CONTROL SYSTEMS

REFRIGERATION

DAMPERS

FILTERS

DIFFUSERS

Linear Slot

Louvre Face

Sidewall

Perforated Face

Vee Face Two Way

Circular

Swirl

Ceiling

Sidewall

Single and Double Deflection

Sidewall Fixed and Adjustable

Jet Flow

ACOUSTIC PRODUCTS

Attenuators

DISPLACEMENT

GRILLES

Linear Bar

Ceiling

Sidewall

Floor

Computer Floor

Cill

Single and Double Deflection

Egg Crate

Hinged Core

Door Transfer

Security and Prison

LOUVRES

External

Circular

Door

Screens

Penthouse

Acoustic

